

THE PROPERTY OF THE DRAWING IS ESTABLISHED BY LAW. IT IS FORBIDDEN TO PRODUCE OR SHOW IT TO THIRD PART. WITHOUT A WRITTEN AGREEMENT.

Item	Name	Q.ty
1	R.4.SCH	1
2	V.TCE4x16	1
3	WKA.10.10.90	1

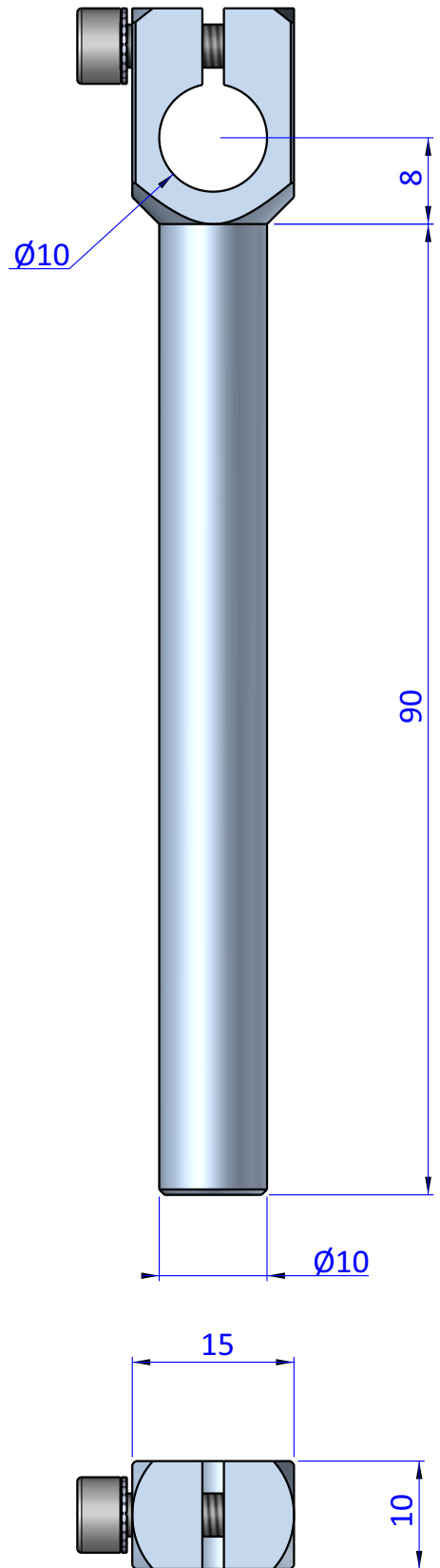

FPSERVICES AUTOMATION

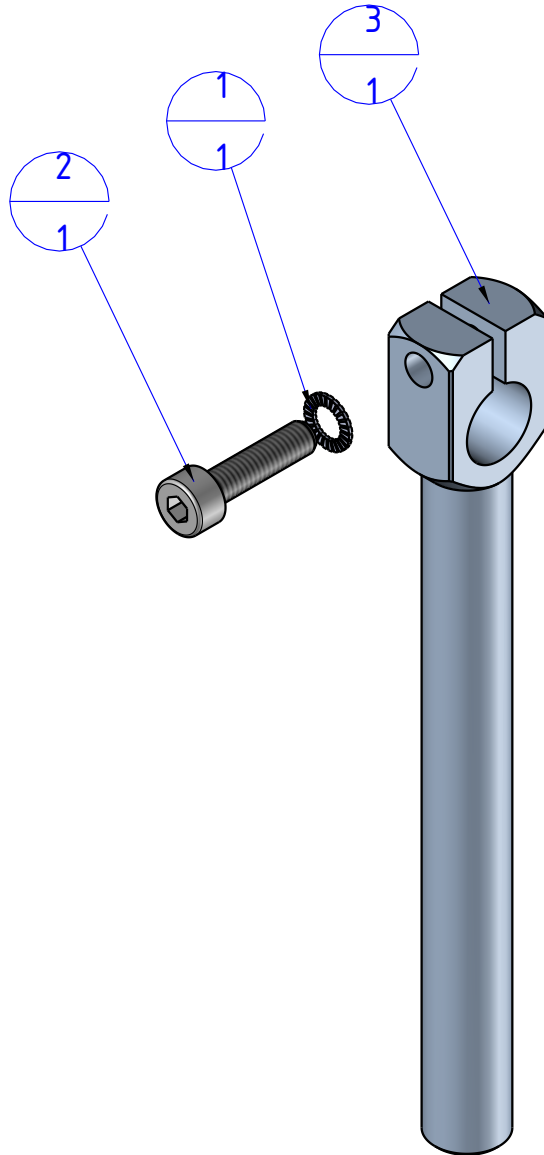
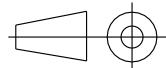

DESIGNED FROM		REVIEW
FPS Automation		A
DATE	WEIGHT	
21/09/2020	0,021kg	
CODE		
CA.WKA.10.10.90		

Format A4

UNI 936-76

GENERAL TOLERANCE

UNI - ISO 2768

CLASSE f

DESCRIPTION

CA.WKA.10.10.90